

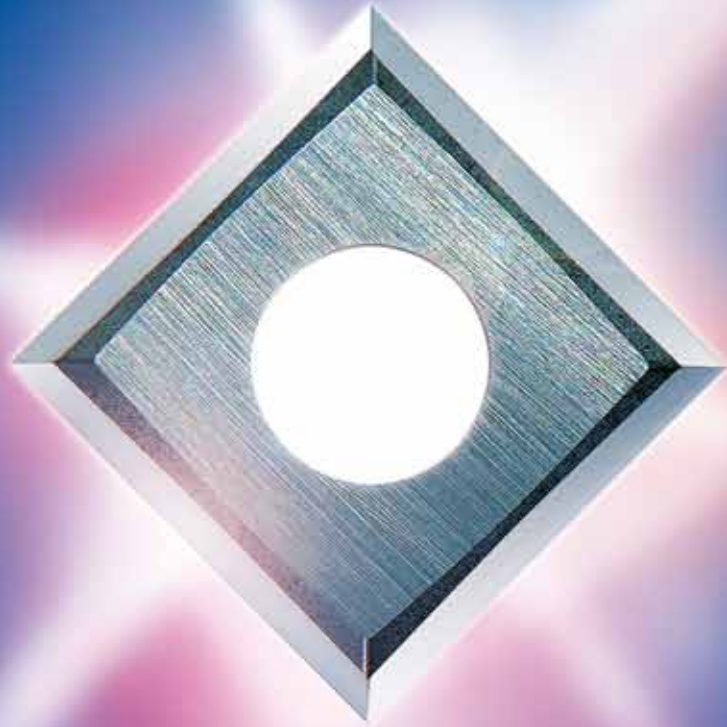











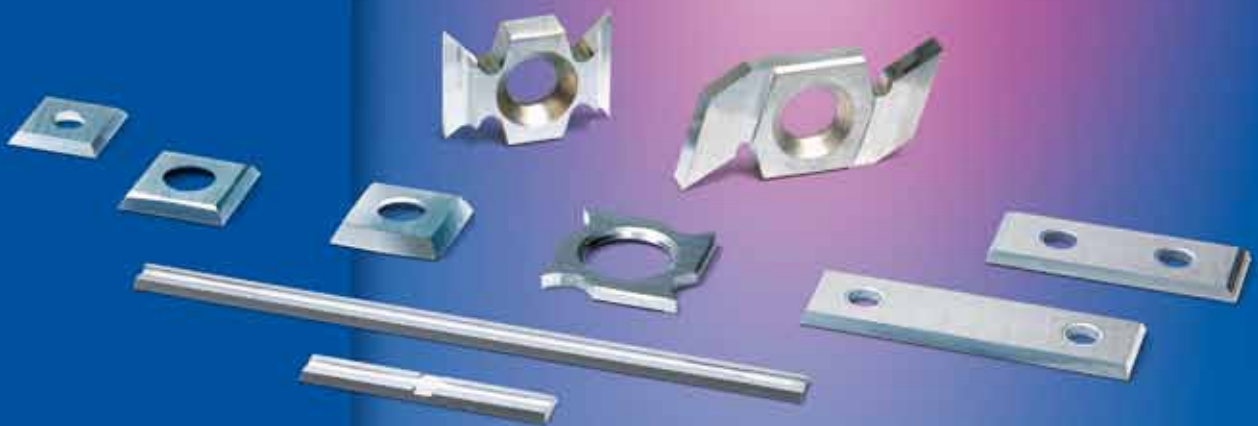

**Tools cut better  
with TIGRA**







-  **Reversible knives and edge rounding knives**
-  **Wendeschneidplatten und Kantenrunder**
-  **Plaquettes reversibles et couteaux brise-arrête**
-  **Coltelli reversibili e spigolatori**
-  **Cuchillas reversibles y cuchillas para aristas**





















-  **Reversible knives - TIGRA carbide grades and their applications** – Technical Data
-  **Wendeschneidplatten - TIGRA Hartmetallsorten und ihre Anwendungen** – Technische Daten
-  **Plaquettes reversibles - Les nuances de carbures TIGRA et leurs applications** – Caractéristiques techniques
-  **Coltelli reversibili - I tipi di metallo duro TIGRA e le loro applicazioni** – Dati tecnici
-  **Cuchillas reversibles - Calidades de metal duro TIGRA y sus aplicaciones** – Datos técnicos

 TIGRA grade  TIGRA - Sorte  Nuance TIGRA  Tipo TIGRA  Calidad TIGRA	Binder	Hardness		Bending strength		Toughness
	Binder Liant Legante Composicion	Härte Dureté Durezza Dureza		Biegebruchfestigkeit Resistance à la flexion Resistenza flessionale Resistencia a la flexión		Zähigkeit Ténacité Tenacità Tenacidad
	%	HV 10	HRA ± 0.2	N/mm <sup>2</sup>	psi	K <sub>1C</sub> / MPa.m <sup>-1/2</sup>
<b>T02UMG</b> ISO: K01 USA: C4 +++	2.0	2550	> 95.5	2300	334.000	5.4
<b>T02SMG</b> ISO: K01 USA: C4 +++	2.5	2350	95.3	2000	290.000	5.7
<b>T03SMG</b> ISO: K01 USA: C4 ++	3.5	2100	94.6	2400	348.000	6.4
<b>T04F</b> ISO: K05 USA: C4	4.0	1750	92.8	2350	341.000	8.6
<b>T08CR*</b> ISO: K01 USA: C4 +	4.3	1900	93.6	2350	341.000	8.5
<b>T05UMG</b> ISO: K01-K10 USA: C3 ++	5.0	2050	94.5	2450	355.000	6.9
<b>T06M</b> ISO: K20 USA: C3 -	6.5	1400	90.3	2400	348.000	10.4
<b>T06MF</b> ISO: K20 USA: C3	6.5	1600	92.0	2500	363.000	9.9
<b>T06MG</b> ISO: K01-K20 USA: C3 ++	6.0	1800	93.3	2700	392.000	8.2
<b>T08MF</b> ISO: K30 USA: C2	8.5	1470	90.9	2700	392.000	10.3
<b>T08SMG</b> ISO: K05-K30 USA: C2 +++	9.0	1750	92.8	3400	493.000	8.4
<b>T10MG</b> ISO: K10-K40 USA: C3 +	10.0	1650	92.3	3600	522.000	9.4



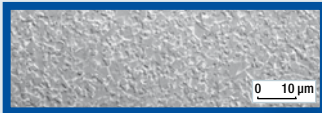
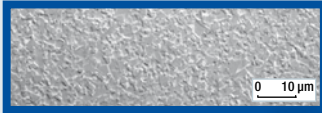

\* Special binder - Spezialbinder - Liant special - Legante speciale - Composicion especial





 TIGRA grade  TIGRA - Sorte  Nuance TIGRA  Tipo TIGRA  Calidad TIGRA	HDF	MDF	Chipboard Spanplatte Panneaux de particule Truciolare Panel de aglomerado	Hardwood Hartholz Bois dur Legno duro Madera dura	Softwood Weichholz Bois tendre Legno tenero Madera blanda
	<b>T02UMG</b>	+++	+++	+	--
<b>T02SMG</b>	++	+++	+++	-	--
<b>T03SMG</b>	+	++	+++	0	--
<b>T04F</b>	0	+	++	+	+
<b>T08CR*</b>	0	++	++	++	+
<b>T05UMG</b>	+	+	+	+++	+
<b>T06MF</b>	-	-	-	0	+
<b>T08MF</b>	-	-	-	+	+
<b>T10MG</b>	-	0	0	++	++











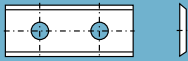





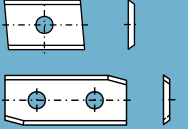























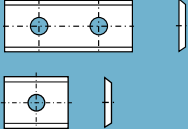





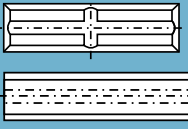





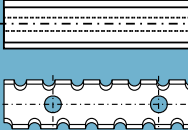





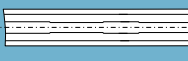

-  Reversible knives - TIGRA carbide grades and their applications
-  Wendeschneidplatten - TIGRA Hartmetallsorten und ihre Anwendungen
-  Plaquettes reversibles - Les nuances de carbures TIGRA et leurs applications
-  Coltelli reversibili - I tipi di metallo duro TIGRA e le loro applicazioni
-  Cuchillas reversibles - Calidades de metal duro TIGRA y sus aplicaciones



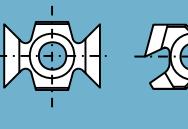

 TIGRA grade  TIGRA - Sorte  Nuance TIGRA  Tipo TIGRA  Calidad TIGRA	Main usage Hauptanwendung Principal usage Main uso Uso principal	
<b>T02UMG</b>	Standard reversible knives Standard-Wendeschneidplatten Plaquettes reversibles standard Coltelli reversibili standard Cuchillas reversibles standard	
<b>T02SMG</b>	Standard reversible knives Standard-Wendeschneidplatten Plaquettes reversibles standard Coltelli reversibili standard Cuchillas reversibles standard	
<b>T03SMG</b>	Standard and mini reversible knives Standard- und Mini-Wendeschneidplatten Plaquettes reversibles standard et mini Coltelli reversibili standard e mini Cuchillas reversibles standard y mini	
<b>T04F</b>	Reversible knives - universal grade Wendeschneidplatten - Universalsorte Plaquettes reversibles - nuance universelle Coltelli reversibili - metallo duro universale Cuchillas reversibles - calidad universal	
<b>T08CR</b>	Reversible knives, planer knives Wendeschneidplatten, Hobelkopfplatten Plaquettes reversibles, couteaux pour outils à raboter Coltelli reversibili, coltelli per teste da pialla Cuchillas reversibles, cuchillas para cepillar	
<b>T05UMG</b>	Special reversible knives Sonder-Wendeschneidplatten Plaquettes reversibles especiales Coltelli reversibili speciali Cuchillas reversibles especiales	
<b>T06MF</b>	Grooving knives Nuter Couteaux pour rainures Coltelli per incastri Cuchillas para ranura	
<b>T08MF</b>	Spurs, portable planers Vorschneider, Handhobel Araseurs, rabots electro portatifs Rasanti, piallatrici portatili Incisores, acepilladoras electricas	
<b>T10MG</b>	45° knives, planer knives 45°-Wendeschneidplatten, Hobelkopfplatten Plaquettes 45°, couteaux pour outils à raboter Coltelli 45°, coltelli per teste da pialla Cuchillas 45°, cuchillas para cepillar	

  

					
+++	Excellent	Hervorragend	Parfaitement	Ottimo	Perfectamente
++	Very Good	Sehr gut	Très bien	Molto idoneo	Muy
+	Good	Gut	Bien	Idoneo	Algo
0	Acceptable	Akzeptabel	Acceptable	Accettabile	Acceptable
-	Not too good	Weniger gut	Moins bien	Meno idoneo	Mal
--	Poor	Schlecht geeignet	Mal adapté	Poco idoneo	Nada apropiado
---	Not suitable	Nicht geeignet	Pas utilisable	Non utilizzabile	No utilizable

-  Reversible knives and edge rounding knives
-  Wendeschneidplatten und Kantenrunder
-  Plaquettes reversibles et couteaux brise-arrête
-  Coltelli reversibili e spigolatori
-  Cuchillas reversibles y cuchillas para aristas

	<ul style="list-style-type: none"> <li> Standard reversible knives 35°</li> <li> Standard Wendeschneidplatten 35°</li> <li> Plaquettes reversibles standard 35°</li> <li> Coltelli reversibili standard 35°</li> <li> Cuchillas reversibles standard 35°</li> </ul>	<b>13-14</b>
	<ul style="list-style-type: none"> <li> Reversible knives</li> <li> Wendeschneidplatten</li> <li> Plaquettes reversibles</li> <li> Coltelli reversibili</li> <li> Cuchillas reversibles</li> </ul>	<b>15</b>
	<ul style="list-style-type: none"> <li> Square knives</li> <li> Quadratische Wendeschneidplatten</li> <li> Plaquettes reversibles à quatre coupes</li> <li> Coltelli reversibili quadrati</li> <li> Cuchillas reversibles cuadradas</li> </ul>	<b>16-18</b>
	<ul style="list-style-type: none"> <li> Spurs, grooving knives</li> <li> Vorschneider, Nuter</li> <li> Araseur, couteaux pour rainures</li> <li> Rasanti, coltelli per incastri</li> <li> Incisores, cuchillas para ranura</li> </ul>	<b>19</b>
	<ul style="list-style-type: none"> <li> Standard reversible knives - 4 cutting edges</li> <li> Standard Wendeschneidplatten - 4 Schneidkanten</li> <li> Plaquettes reversibles standard - 4 tranchants</li> <li> Coltelli reversibili standard - 4 taglienti</li> <li> Cuchillas reversibles standard - 4 filos de corté</li> </ul>	<b>20</b>
	<ul style="list-style-type: none"> <li> Reversible knives 45°</li> <li> Wendeschneidplatten 45°</li> <li> Plaquettes reversibles 45°</li> <li> Coltelli reversibili 45°</li> <li> Cuchillas reversibles 45°</li> </ul>	<b>21</b>
	<ul style="list-style-type: none"> <li> Mini reversible knives</li> <li> Mini-Wendeschneidplatten</li> <li> Mini plaquettes reversibles</li> <li> Mini coltelli reversibili</li> <li> Mini cuchillas reversibles</li> </ul>	<b>22</b>
	<ul style="list-style-type: none"> <li> Reversible knives for Systems Leitz, Oertli, KWO/Versofix, with chip breakers</li> <li> Wendeschneidpl. für Systeme Leitz, Oertli, KWO/Versofix, mit Spanbrechernuten</li> <li> Plaquettes rev. pour Systèmes Leitz, Oertli, KWO/Versofix, avec brise copeux</li> <li> Coltelli reversibili per sistemi Leitz, Oertli, KWO/Versofix, con rompitrucolo</li> <li> Cuchillas rev. para sistemas Leitz, Oertli, KWO/Versofix, con rompevirutas</li> </ul>	<b>23-24</b>
	<ul style="list-style-type: none"> <li> Reversible knives for portable planers</li> <li> Wendeplatten für Handhobel</li> <li> Plaquettes pour rabots électro portatifs</li> <li> Coltelli per piallatrici portatili</li> <li> Cuchillas para acepilladoras electricas</li> </ul>	<b>25</b>
	<ul style="list-style-type: none"> <li> Edge rounding knives</li> <li> Kantenrunder</li> <li> Couteaux brise-arrête</li> <li> Spigolatori</li> <li> Cuchillas para aristas</li> </ul>	<b>26</b>



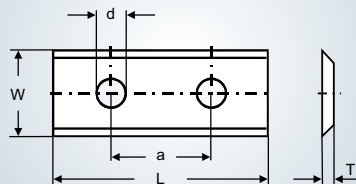

-  Standard reversible knives
-  Standard-Wendeschneidplatten
-  Plaquettes reversibles standard
-  Coltelli reversibili standard
-  Cuchillas reversibles standard

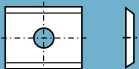
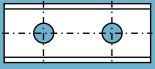

35 °

	L mm	W mm	T mm	a mm	T04F	T02UMG	T02SMG	T03SMG	T10MG	T08CR
	7.5	12.0	1.5		012001			013811	013963	106822
	8.6	12.0	1.5		013182					
	9.0	12.0	1.5		012043					
	9.6	12.0	1.5		012015			013850	014010	106823
	10.0	12.0	1.5		013165					
	10.5	12.0	1.5		013167					
	11.0	12.0	1.5		013168					
	11.6	12.0	1.5		013183					
	13.0	12.0	1.5		013170					
	13.6	12.0	1.5		013185					
	14.6	12.0	1.5		013186					
	15.0	12.0	1.5		012003			013819	013972	106824
	15.7	12.0	1.5		013172					
	16.0	12.0	1.5		013203					
	17.0	12.0	1.5		013173					
18.0	12.0	1.5		013174						
19.0	12.0	1.5		013175						
20.0	12.0	1.5		012004	115081	041587	013823	013977	104796	
25.0	12.0	1.5		012025			013853	014013	106826	
	25.0	12.0	1.5	14.0	012011			013843	014001	106827
	30.0	12.0	1.5	14.0	012005	115082	037750	013828	013982	104795
	35.0	12.0	1.5	26.0	013208					
	40.0	12.0	1.5	26.0	012014	115083	052278	013847	014006	106828
	50.0	12.0	1.5	26.0	012006	115085	037901	013834	013987	106829
	60.0	12.0	1.5	26.0	012007	115086	054882	013839	013994	106830

	L mm	W mm	T mm	a mm	T08MF	T03SMG	T10MG	T08CR	
	80.0	13.0	2.2	60.0	012008		013841	013997	106831
	100.0	13.0	2.2	60.0	012009		030831	013998	106832
	120.0	13.0	2.2	60.0	012010		030832	013999	106833

-  Standard reversible knives
-  Standard-Wendeschneidplatten
-  Plaquettes reversibles standard
-  Coltelli reversibili standard
-  Cuchillas reversibles standard

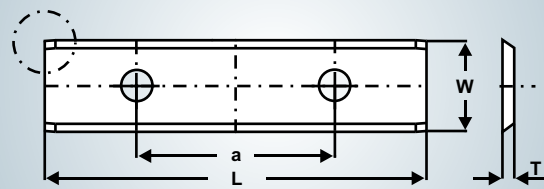



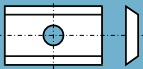
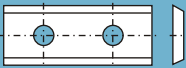

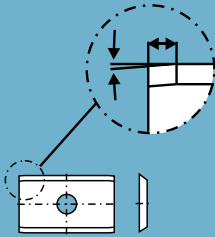
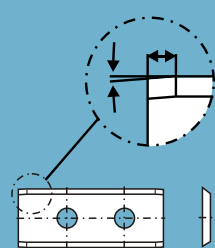
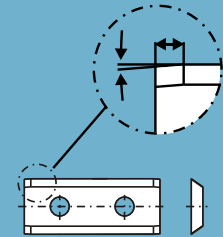

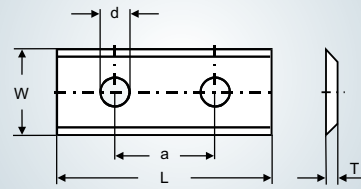

For use in planer heads!  
Für Hobelköpfe!

	L mm	W mm	T mm		T04F	T03SMG
	20.0	12.0	2.5		100686	101037
	30.0	12.0	2.5		054259	101038
	50.0	12.0	2.5		100687	101039

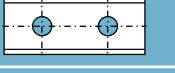
	L mm	W mm	T mm		T04F	T10MG	T08CR
	20.0	12.0	1.5	35°		013979	106674
	24.0	12.0	1.5	40°	104119	041060	106675
	24.7	12.0	1.5	35°	104120		106676
	30.0	12.0	1.5	35°		013984	106677
	40.0	12.0	1.5	35°		014008	106678
	50.0	12.0	1.5	35°		013989	106679
	60.0	12.0	1.5	35°			106680
	30.0	12.0	2.5	35°	102283		

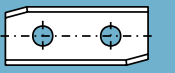
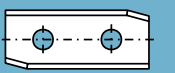
-  Reversible knives
-  Wendeschneidplatten
-  Plaquettes reversibles
-  Coltelli reversibili
-  Cuchillas reversibles

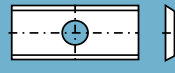
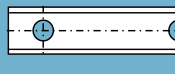

	L mm	W mm	T mm	a mm	T04F	T03SMG	T10MG
	20.0	14.3	2.5		013730	033492	033491
	44.5	15.0	1.5	25.0	013447		
	30.0	12.0	1.5	16.0	013449	033490	033477
	24.0	12.0	1.5		013241		
	30.0	12.0	1.5	14.0	013430	013924	033466
	50.0	12.0	1.5	26.0	013432	033470	033468
	30.0	12.0	1.5	14.0	013431	013925	033467
	50.0	12.0	1.5	26.0	013433	033471	033469
	20.0	12.0	1.5		013436	033480	033479
	20.0	12.0	1.5		013441	033481	033482
	30.0	12.0	1.5	14.0	013437	013926	033489
	40.0	12.0	1.5	26.0	013440		
	50.0	12.0	1.5	26.0	013438	013927	014038
	30.0	12.0	1.5	14.0	013442	013928	033484
	40.0	12.0	1.5	26.0	013445		
	50.0	12.0	1.5	26.0	013443	013929	014039

	L mm	W mm	T mm	a mm	T04F
	20.0	9.0	1.5		013195
	24.0	9.0	1.5	14.0	013197
	30.0	9.0	1.5	14.0	013199
	40.0	9.0	1.5	26.0	013200
	50.0	9.0	1.5	26.0	013201

 Square knives



 Quadratische Wendeschneidplatten

 Plaquettes reversibles à quatre coupes

 Coltelli reversibili quadrati

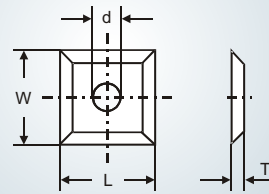
 Cuchillas reversibles cuadradas

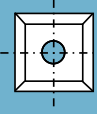
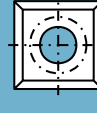

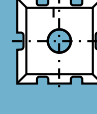
	L mm	W mm	T mm	d mm	T08MF	T04F	T02SMG	T03SMG	T10MG	T08CR	
	9.0	9.0	1.5	35°	4.0	100744					
	10.5	10.5	1.5	35°	4.0	013259		013863	014027	106834	
	12.0	12.0	1.5	35°	4.0	012002	048357	013815	013968	106835	
	13.0	13.0	2.5	35°	4.0	013328					
	17.0	17.0	2.0	35°	3.0	016565	016564				
	17.0	17.0	2.0	35°	4.0	013266	013265		013864	030830	106836
	19.0	19.0	2.0	35°	4.0		013264		030838	030827	106837
	10.5	10.5	1.5	35°						106682	
	13.0	13.0	2.5	30°	013324						
	13.6	13.6	2.0	30°	013299						
	13.6	13.6	2.0	45°	037522						
	14.0	14.0	1.2	30°	013295						
	14.0	14.0	1.7	22°	013297						
	14.0	14.0	1.7	30°	013307						
14.0	14.0	2.0	30°	013273	013260	054962	013865	014028	102558		
 For Holz-Her system*	14.0	14.0	1.2	30°	013303						
	15.0	15.0	2.0		013322				014029		

\* For use in Holz-Her cutterheads only

\* Nur zur Verwendung in Messerköpfen der Firma Holz-Her

\* Utilisation limitée aux porte outils de l'entreprise Holz-Her

\* Da usare solo su teste portacoltelli della Holz-Her

\* Sólo para empleo con portacuchillas de la firma Holz-Her





 Square knives

 Quadratische Wendschneidplatten

 Plaquettes reversibles à quatre coupes

 Coltelli reversibili quadrati

 Cuchillas reversibles cuadradas

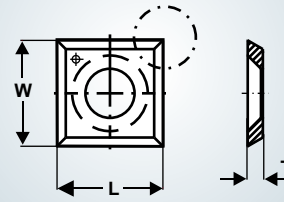

For use in planer heads!  
Für Hobelköpfe!

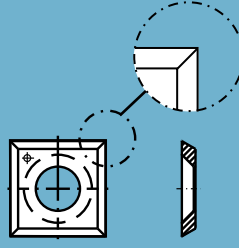
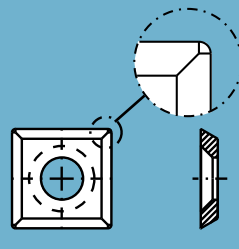
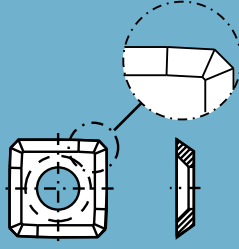
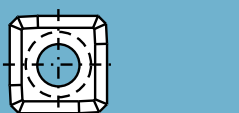
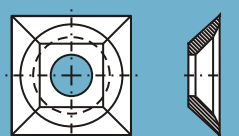
	L	W	T		T08MF	T04F	T10MG	T08CR	TL15
	mm	mm	mm						
<b>Straight with sharp edges</b> 	10.5	10.5	1.5	35°				106682	040343
	14.0	14.0	2.0	30°	013273	013260	014028	102558	013771
	14.0	14.0	2.0	37°	104295		104900		
	14.3	14.3	2.5	35°			013329	106683	
	14.6	14.6	2.5	30°			013314	106684	
	15.0	15.0	2.5	30°			013315	106685	
	15.0	15.0	2.5	37°			104062		
<b>Straight with rounded edges</b> 	14.0	14.0	2.0	30°	013276		104117		
	14.3	14.3	2.5	30°			104208		
	14.6	14.6	2.5	30°			013316		
	15.0	15.0	2.5	30°			104118		
	15.0	15.0	2.5	37°			109384		
<b>left</b>  <b>For System Ledinek *</b> <b>right</b> 	14.3	14.3	2.5	35°			053589		
	14.3	14.3	2.5	35°			053590		
	21.0	21.0	5.5	40°			022695		

\* For use in Ledinek-cutterheads only

\* Nur zur Verwendung in Messerköpfen der Firma Ledinek

\* Utilisation limitée aux porte outils de l'entreprise Ledinek

\* Da usare solo su teste portacoltelli della Ledinek

\* Sólo para empleo con portacuchillas de la firma Ledinek

 Square knives

 Quadratische Wendschneidplatten

 Plaquettes reversibles à quatre coupes



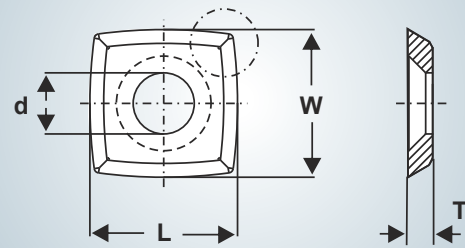

 Coltelli reversibili quadrati

 Cuchillas reversibles cuadradas

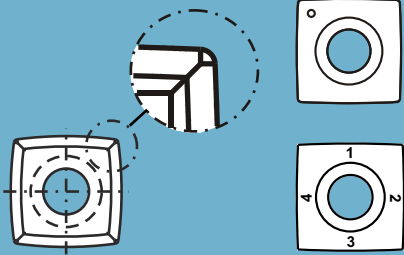
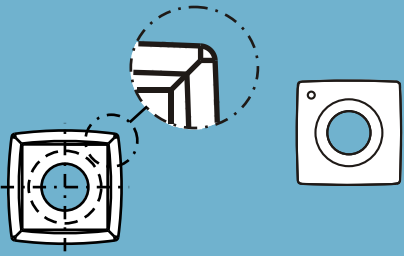
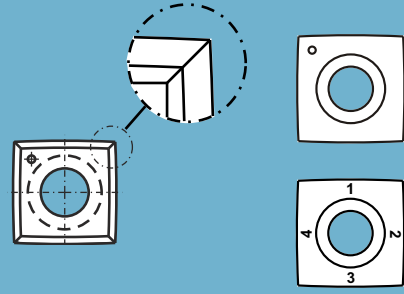
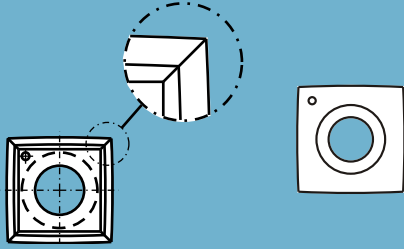

For use in planer heads!  
Für Hobelköpfe!



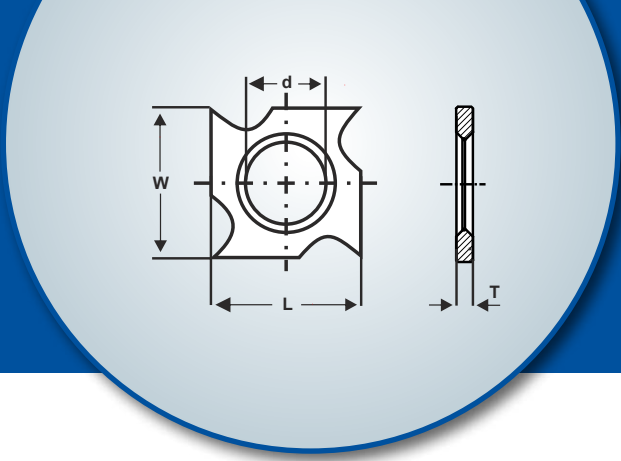

	L	W	T	R	T10MG
	mm	mm	mm		
<b>Cutting edge with radius and rounded edges</b> 	15.0	15.0	2.5	R=150	013320
	15.0	15.0	2.5	R=150	101540
	15.0	15.0	2.5	R=115	115179
	14.0	14.0	2.0	R=150	100788
	14.6	14.6	2.5	R=150	052673
	15.0	15.0	2.5	R=50	043895
<b>Cutting edge with radius and pointed edges</b> 	15.0	15.0	2.5	R=150	100791
	15.0	15.0	2.5	R=100	101180
	15.0	15.0	2.5	R=150	104115
	14.0	14.0	2.0	R=150	100789
	14.6	14.6	2.5	R=150	100790
	15.0	15.0	2.5	R=50	101044

-  Spurs, grooving knives
-  Vorschneider, Nuter
-  Araseur, couteaux pour rainures
-  Rasanti, coltelli per scanalature
-  Incisores, cuchillas para ranura

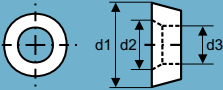



	L mm	W mm	T mm		d mm	T08MF	T04F	T06MF	T10MG
	18.0	18.0	1.95			013293			
	18.0	18.0	2.45			013291			
	18.0	18.0	2.95			013305			
	18.0	18.0	3.70			013289			
	22.9	19.8	2.5	30°		045180			
	22.0	19.0	2.0	30°		013271			
	(22.0)	(22.0)	(2.0)						
	14.0	28.0	2.0	30°		013258			
	16.0	16.0	3.0	32°		030829			
	18.5		3.25	30°					017190
	33.5				3.0	013252			
	18.9	7.9	4.0			013253			
	18.0	5.7	3.5				013255		
	24.5	13.0	4.0					053640	
	24.5	13.0	5.0					053641	
	34.0	16.0	4.0					013278	
	34.0	16.0	5.0					013279	
	34.0	16.0	6.0					013280	
	34.0	16.0	7.0					013281	



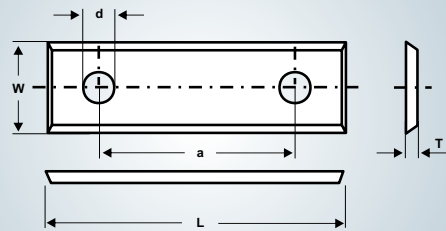

	d1 mm	d2 mm	d3 mm	T mm		T03SMG
	11.0	7.0	5.1	4.0		013373

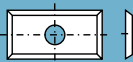
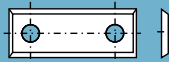
-  Standard reversible knives
-  Standard Wendeschneidplatten
-  Plaquettes reversibles standard
-  Coltelli reversibili standard
-  Cuchillas reversibles standard

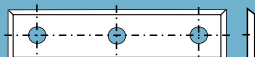
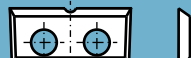
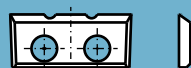
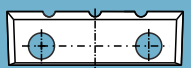
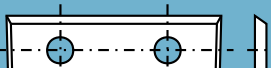



4 cutting edges  
4 Schneidkanten  
4 tranchants  
4 taglienti  
4 filos de corte

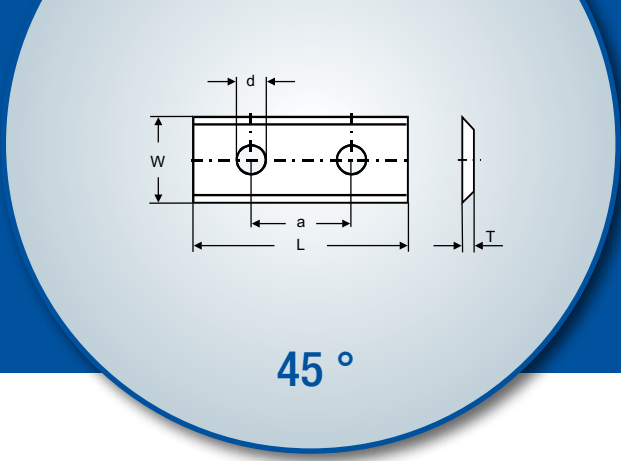

	L mm	W mm	T mm	a mm	T04F	T03SMG	T10MG	TL15
	19.5	7.0	1.5		013492	030874	030886	030904
	19.5	7.5	1.5		013493	030875	030887	030905
	19.5	8.0	1.5		013494	013945	030888	030906
	19.5	9.0	1.5		013495	013946	030889	030907
	19.5	10.0	1.5		013496	030876	030890	030908
	19.5	11.0	1.5		013497	030877	030891	030909
	19.5	12.0	1.5		013498	013947	030892	013774
	29.5	7.0	1.5	14.0	013501	030878	030893	030910
	29.5	7.5	1.5	14.0	013502	013948	030894	030911
	29.5	8.0	1.5	14.0	013503	013949	030895	030912
	29.5	9.0	1.5	14.0	013504	013950	030896	030913
	29.5	10.0	1.5	14.0	013505	030879	030897	030914
	29.5	11.0	1.5	14.0	013506	030880	030898	030915
	29.5	12.0	1.5	14.0	013507	013952	014088	013775
	39.5	9.0	1.5	26.0	013511	045134		
	39.5	12.0	1.5	26.0	013512	013954	014089	030916
	49.5	8.0	1.5	26.0	013516	013955	030899	030917
	49.5	9.0	1.5	26.0	013517	013956	030900	030918
	49.5	10.0	1.5	26.0	013518	030881	030901	030919
	49.5	11.0	1.5	26.0	013519	030882	030902	030920
	49.5	12.0	1.5	26.0	013520	013957	014090	013776
	59.5	12.0	1.5	26.0	013523	013958	030903	030921
	50.0	9.0	1.5	37.0	016950	035425		
	50.0	10.0	1.7	37.0	016966	030883	030884	
	50.0	12.0	1.7	37.0	013327	013866	014030	
	16.0	7.0	1.5	7.0	048995	052579		
	16.0	7.0	1.5	7.0	048996	052580		
	23.0	7.0	1.5	14.0	106866			
	23.0	7.0	1.5	14.0	106867			
	16.0	7.0	1.5	7.0	016934	016933		
	23.0	7.0	1.5	14.0	053449			
	28.0	7.0	1.5	14.0	016823	016822		
	31.5	9.0	1.5	14.0	109149			

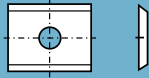
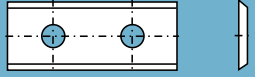



-  Reversible knives
-  Wendeschneidplatten
-  Plaquettes reversibles
-  Coltelli reversibili
-  Cuchillas reversibles

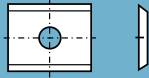
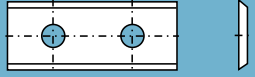

	L mm	W mm	T mm	a mm		T08MF	T10MG	TL15
	7.5	12.0	1.5		45°		014091	013777
	9.6	12.0	1.5		45°		014115	030851
	15.0	12.0	1.5		45°		014098	013780
	20.0	12.0	1.5		45°		014100	013781
	25.0	12.0	1.5		45°		014123	013788
	25.0	12.0	1.5	14.0	45°		014110	013786
	30.0	12.0	1.5	14.0	45°		014102	013783
	40.0	12.0	1.5	26.0	45°		014113	013787
	50.0	12.0	1.5	26.0	45°		014105	013784
	60.0	12.0	1.5	26.0	45°		014107	013785
	12.0	12.0	1.5		45°		014096	013778
	80.0	13.0	2.2	60.0	45°	013532	038233	



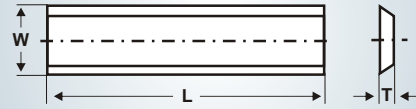

**>>MICROFINISH<<**

	L mm	W mm	T mm	a mm		T10MG	TL15
	7.5	12.0	1.5		45°	014093	030861
	9.6	12.0	1.5		45°	014117	030864
	15.0	12.0	1.5		45°	014099	030862
	20.0	12.0	1.5		45°	014101	013782
	25.0	12.0	1.5		45°	014124	030865
	25.0	12.0	1.5	14.0	45°	014111	030863
	30.0	12.0	1.5	14.0	45°	014103	030866
	40.0	12.0	1.5	26.0	45°	014114	030870
	50.0	12.0	1.5	26.0	45°	014106	030868
	60.0	12.0	1.5	26.0	45°	014108	030869
	12.0	12.0	1.5		45°	014097	013779

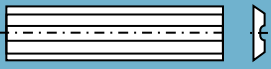
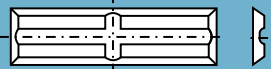
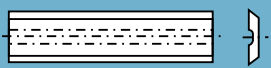
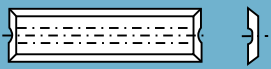
-  Mini reversible knives
-  Mini-Wendescheidplatten
-  Mini plaquettes reversibles
-  Mini coltelli reversibili
-  Mini cuchillas reversibles



	L mm	W mm	T mm	T04F	T03SMG	Style
	12.0	5.5	1.1	013355	013882	Back groove
	20.0	5.5	1.1	013357	013884	Rückennut
	30.0	5.5	1.1	013363	013890	Rainure sur petite face
	40.0	5.5	1.1	013359	013886	Scanalatura posteriore
	50.0	5.5	1.1	013361	013888	Ranura de lomo
	20.0	4.1	1.1	013403		Back and crossgroove
	20.0	5.5	1.1	013394	013911	Rücken- und Quernut
	25.0	5.5	1.1	013402	013920	Rainure transversal
	30.0	5.5	1.1	013397	013914	Scanalatura di sicurezza
	40.0	5.5	1.1	013399	013916	Ranura transversal
	50.0	5.5	1.1	013401	013918	
	12.0	5.5	1.1	013334	013870	Face groove
	20.0	5.5	1.1	013336	013872	Brustnut
	30.0	5.5	1.1	013345	013880	Rainure sur grande face
	40.0	5.5	1.1	013339	013874	Scanalatura frontale
	50.0	5.5	1.1	013342	013877	Ranura frontal
	20.0	5.5	1.1	013378	030871	4 Cutting edges
	25.0	5.5	1.1	013376	030872	4 Schneidkanten
	30.0	5.5	1.1	013379	030847	4 Tranchants
	35.0	5.5	1.1	013377	013893	4 Taglienti
						4 Filos de corte
	40.0	5.5	1.1	013380	013898	
	44.5	5.5	1.1	013375	030873	
	50.0	5.5	1.1	013381	013900	

-  Reversible knives for systems
-  Wendeschneidplatten für Systeme
-  Plaquettes reversibles pour les systèmes
-  Coltelli reversibili per sistemi
-  Cuchillas reversibles para sistemas

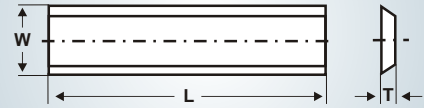

For Systems Leitz and Oertli

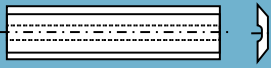
For Leitz system*	L mm	W mm	T mm	T04F	T03SMG	T10MG
	7.7	8.0	1.5	013457	013930	014041
	9.7	8.0	1.5	013470	013942	014065
	11.7	8.0	1.5	013458	013931	014043
	14.7	8.0	1.5	013459	013932	014045
	19.7	8.0	1.5	013460	013933	014047
	24.7	8.0	1.5	013472	013943	014068
	30.0	8.0	1.5	013461	013934	014049
	35.0	8.0	1.5	013462	013935	014051
	40.0	8.0	1.5	013463	013936	014053
	45.0	8.0	1.5	013488	049488	014081
	50.0	8.0	1.5	013464	013937	014055
	60.0	8.0	1.5	013466	013938	014057
	70.0	8.0	1.5	013478	030927	014074
	80.0	8.0	1.5	013467	013939	014059
	100.0	8.0	1.5	013468	013940	014061
	120.0	8.0	1.5	013469	049489	014063

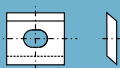
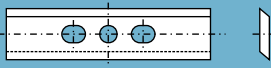
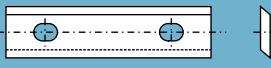
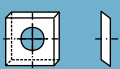
For Oertli system*	L mm	W mm	T mm	T04F	T10MG
	8.8	8.0	1.5	030931	017193
	9.0	8.0	1.5	030932	017194
	9.5	8.0	1.5	030933	017195
	11.0	8.0	1.5	030934	017196
	12.0	8.0	1.5	030935	017197
	15.0	8.0	1.5	030936	017198
	20.0	8.0	1.5	030937	017200
	25.0	8.0	1.5	030938	017201
28.0	8.0	1.5	030939	017202	
	32.0	8.0	1.5	030940	017203
	40.0	8.0	1.5	030941	017204
	50.0	8.0	1.5	030942	017206
	60.0	8.0	1.5	030943	017207
	80.0	8.0	1.5	030944	017209
	100.0	8.0	1.5	030945	017210
	12.0	12.0	1.5	034294	034295





\* For use in Leitz/Oertli-cutterheads only

\* Nur zur Verwendung in Messerköpfen der Firma Leitz bzw. Oertli

\* Utilisation limitée aux porte outils des entreprises Leitz et Oertli

\* Da usare solo su teste portacottelli della Leitz - Oertli

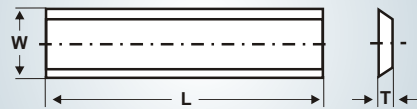

\* Sólo para empleo con portacuchillas de la firma Leitz/Oertli

-  Reversible knives for system
-  Wendeschneidplatten für System
-  Plaquettes reversibles pour le système
-  Coltelli reversibili per sistema
-  Cuchillas reversibles para sistema



For System KWO/Versofix

For KWO/Versofix system*	L mm	W mm	T mm	T03SMG TiN-coated	T10MG TiN-coated
	20.0	5.5	1.1	049525	049526
	30.0	6.5	1.1	101074	101075
	50.0	6.5	1.1	101078	101079
	20.0	10.0	1.5	014273	030841
	30.0	10.0	1.5	014275	030842
	50.0	10.0	1.5	014277	030843
 with chamfer	50.0	10.0	1.5	014279	030844

-  Reversible knives with chip breakers
-  Wendeschneidplatten mit Spanbrechernuten
-  Plaquettes reversibles avec brise copeaux
-  Coltellini con rompitrucolo
-  Cuchillas reversibles con rompevirutas

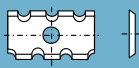
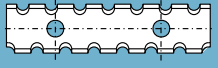
	L mm	W mm	T mm	a mm	T04F
	20.0	12.0	1.5		030928
	30.0	12.0	1.5	14.0	013117
	50.0	12.0	1.5	26.0	013127
	60.0	12.0	1.5	26.0	108318

\* For use in KWO/Versofix-cutterheads only





\* Nur zur Verwendung in Messerköpfen der Firma KWO/Versofix

\* Utilisation limitée aux porte outils de l'entreprise KWO/Versofix



\* Da usare solo su teste portacoltelli della KWO/Versofix

\* Sólo para empleo con portacuchillas de la firma KWO/Versofix



-  Reversible knives for portable planers
-  Wendeschneidplatten für Handhobel
-  Plaquettes pour rabots électro portatifs
-  Coltelli per piallatrici portatili
-  Cuchillas para acepilladoras electricas



	L mm	W mm	T mm	T08MF	
	56.0	5.5	1.1	013041	Adler
	60.0	5.5	1.1	013053	Wegoma
	75.5	5.5	1.1	013001	AEG, Bosch, Festo, Haffner, Kress, Mafell, Metabo, Scheer, Skil, Holz-Her
	78.0	5.5	1.1	013067	Virutex
	92.0	5.5	1.1	013058	AEG, Hitachi, Ryobi
	102.0	5.5	1.1	013061	AEG
	75.7	5.5	1.2	013018	B&D
	80.5	5.9	1.2	013043	ELU
	80.5	5.5	1.1	013010	ELU
	82.0	5.5	1.1	013020	AEG, B&D, Bosch, ALU, Fein, Felisatti, Haffner, Hitachi, Holz-Her, Mafell, Makita, Metabo, Peugeot, Ryobi, Skil
	82.0	5.1	1.2	013034	Face groove, Brustnut, Rainure sur grande face, Scanalatura frontale, Ranura frontal

 Edge rounding knives

 Kantenrunder

 Couteaux brise-arrête

 Spigolatori

 Cuchillas para aristas

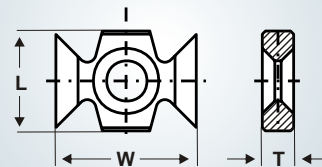

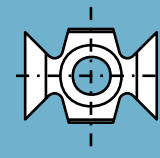
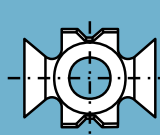
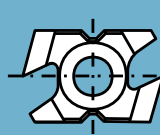
	L mm	W mm	T mm	Type	T10MG
	16.0	22.0	5.0	TKM 45°	032292
	16.0	22.0	5.0	TKM R 1.5	032294
	16.0	22.0	5.0	TKM R 2.0	032295
	16.0	22.0	5.0	TKM R 2.5	032296
	16.0	22.0	5.0	TKM R 3.0	032297
	16.0	22.0	5.0	TKM R 4.0	032299
	16.0	22.0	6.0	TKM R 5.0	032301
 For Leitz-system „Mechanical“ *	15.0	20.0	8.0	TKM 11/0 - 45°	032304
	15.0	22.3	9.0	TKM 12/0 R3	032306
	15.0	20.0	9.0	TKM 12/1 R3	032307
	15.0	20.0	7.3	TKM 12/3 R2	032308
	15.0	18.3	7.3	TKM 12/3 R2F	032309
	15.0	20.0	7.0	TKM 12/4 R1.5	032310
	15.0	22.3	10.0	TKM 12/5 R3F	032311
	15.0	22.3	7.3	TKM 13/0 (R1) N=5	032312
	15.0	22.3	9.0	TKM 13/1 (R1) N=7	032313
	15.0	22.3	7.3	TKM 16/0	032315
 For Leitz-system “BG-Test“ *	15.0	23.0	8.0	TKM 21/0 - 45°	032316
	15.0	23.0	9.0	TKM 22/0 R3	032318
	15.0	23.0	7.3	TKM 22/3 R2	032320
	15.0	23.0	7.0	TKM 22/4 R1.5	032322
	15.0	23.0	9.0	TKM 22/5 R3F	032323
	15.0	23.0	9.0	TKM 22/1 R3	032319
	15.0	25.7	7.3	TKM 24/0 R5	032327
	15.0	25.7	7.3	TKM 24/1 R5	032326

\* For use in Leitz-cutterheads only

\* Nur zur Verwendung in Messerköpfen der Firma Leitz

\* Utilisation limitée aux porte outils de l'entreprise Leitz

\* Da usare solo su teste portacoltelli della Leitz

\* Sólo para empleo con portacuchillas de la firma Leitz